

Technics[®]

Operating Instructions

Compact Disc Player

SL-C700

Music is borderless and timeless,
touching people's hearts across cultures and generations.
Each day the discovery of a truly emotive experience
from an unencountered sound awaits.
Let us take you on your journey to rediscover music.

Rediscover Music™

Technics

Thank you for purchasing this product.
Please read these instructions carefully before using this product, and save this manual for future use.

For the United Kingdom and Ireland customers

Sales and Support Information

Customer Communications Centre

- For customers within the UK: 0333 222 8777
- For customers within Ireland: 01 447 5229
- Monday–Friday 9:00 am – 5:00 pm, (Excluding public holidays).
- For further support on your product, please visit our website: www.technics.com/uk/

■ **Features of this unit**

This unit offers the following features:

High Res Re-master

The High Res Re-master function enables high-precision expansion of bandwidth and bit depth for high-quality sound reproduction from music CDs and other compressed sources.

High Precision Master Clock

A high-precision master clock, generated by very precise crystals, drives all the digital circuits, ensuring accurate reproduction.

High Quality Analog Circuit

Equipped with an L/R independent high-precision parallel DAC that eliminates channel interference and reproduces a rich sound field.

■ **Recommended devices**

We recommend using Technics devices (optional) for superior audio quality.

Product name	Model number
Speaker System	SB-C700
Network Audio Player	ST-C700
Stereo Integrated Amplifier	SU-C700

Safety precautions

WARNING

Unit

- To reduce the risk of fire, electric shock or product damage,
 - Do not expose this unit to rain, moisture, dripping or splashing.
 - Do not place objects filled with liquids, such as vases, on this unit.
 - Use only the recommended accessories.
 - Do not remove covers.
 - Do not repair this unit by yourself. Refer servicing to qualified service personnel.
 - Do not let metal objects fall inside this unit.
 - Do not place heavy items on this unit.

AC mains lead

- To reduce the risk of fire, electric shock or product damage,
 - Ensure that the power supply voltage corresponds to the voltage printed on this unit.
 - Insert the mains plug fully into the socket outlet.
 - Do not pull, bend, or place heavy items on the lead.
 - Do not handle the plug with wet hands.
 - Hold onto the mains plug body when disconnecting the plug.
 - Do not use a damaged mains plug or socket outlet.
- The mains plug is the disconnecting device. Install this unit so that the mains plug can be unplugged from the socket outlet immediately.

CAUTION

Unit

- This unit utilizes a laser. Use of controls or adjustments or performance of procedures other than those specified herein may result in hazardous radiation exposure.
- Do not place sources of naked flames, such as lighted candles, on this unit.
- This unit may receive radio interference caused by mobile telephones during use. If such interference occurs, please increase separation between this unit and the mobile telephone.
- This unit is intended for use in tropical climates.

Placement

- Place this unit on an even surface.
- To reduce the risk of fire, electric shock or product damage,
 - Do not install or place this unit in a bookcase, built-in cabinet or in another confined space. Ensure this unit is well ventilated.
 - Do not obstruct this unit's ventilation openings with newspapers, tablecloths, curtains, and similar items.
 - Do not expose this unit to direct sunlight, high temperatures, high humidity, and excessive vibration.
- Do not lift or carry this unit by holding any of its levers. Doing so may cause this unit to fall, resulting in personal injury or malfunction of this unit.

Safety information for customers in Norway

NORSK

ADVARSEL

Produkt

- For å redusere faren for brann, elektrisk støt eller skade på apparatet:
 - Utsett ikke produktet for regn, fukt, drypping eller sprut.
 - Ikke plasser objekter som er fylt med væske, som vaser, på apparatet.
 - Bruk kun anbefalt tilbehør.
 - Fjern ikke deksler.
 - Reparer ikke denne enheten selv, overlatt service til kvalifisert servicepersonell.

Vekselstrømnett

- Nettstøpselet er trukket ut fra denne enheten. Installer denne enheten slik at nettstøpselet umiddelbart kan trekkes fra stikkontakten.

FORSIKTIG

Produkt

- Dette produktet anvender en laser. Betjening av kontroller eller justering eller andre inngrep enn de beskrevet i denne bruksanvisning kan føre til farlig bestråling.
- Plasser ikke åpen ild, slik som levende lys, oppå apparatet.
- Denne enheten er beregnet for bruk i tropiske klimaer.

Plassering

- For å redusere faren for brann, elektrisk støt eller skade på apparatet:
 - Ikke plasser apparatet i en bokhylle, et innebygget kabinett eller et annet lukket sted. Pass på at produktet er godt ventilert.
 - Apparatets ventilasjonsåpninger må ikke dekkes til med aviser, duker, gardiner eller lignende.

(Back of product)

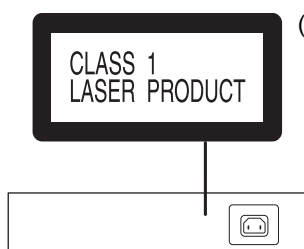



Caution for AC Mains Lead

(For the AC mains plug of three pins)

For your safety, please read the following text carefully.

This appliance is supplied with a moulded three pin mains plug for your safety and convenience.

A 13-ampere fuse is fitted in this plug.

Should the fuse need to be replaced please ensure that the replacement fuse has a rating of 13-ampere and that it is approved by ASTA or BSI to BS1362. Check for the ASTA mark  or the BSI mark  on the body of the fuse.

If the plug contains a removable fuse cover you must ensure that it is refitted when the fuse is replaced.

If you lose the fuse cover the plug must not be used until a replacement cover is obtained.

A replacement fuse cover can be purchased from your local dealer.

Before use

Remove the connector cover.

How to replace the fuse

The location of the fuse differ according to the type of AC mains plug (figures A and B). Confirm the AC mains plug fitted and follow the instructions below. Illustrations may differ from actual AC mains plug.

- Open the fuse cover with a screwdriver.

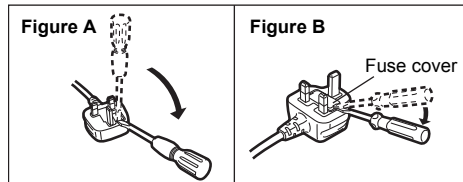

- Replace the fuse and close or attach the fuse cover.

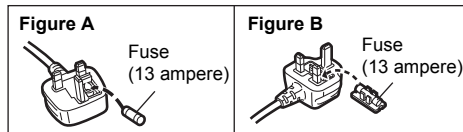

Disposal of Old Equipment

Only for European Union and countries with recycling systems



This symbol on the products, packaging, and/or accompanying documents means that used electrical and electronic products must not be mixed with general household waste.

For proper treatment, recovery and recycling of old products, please take them to applicable collection points in accordance with your national legislation.

By disposing of them correctly, you will help to save valuable resources and prevent any potential negative effects on human health and the environment.

For more information about collection and recycling, please contact your local municipality.

Penalties may be applicable for incorrect disposal of this waste, in accordance with national legislation.

MPEG Layer-3 audio coding technology licensed from Fraunhofer IIS and Thomson.

Windows Media and the Windows logo are trademarks or registered trademarks of Microsoft Corporation in the United States and/or other countries. This product is protected by certain intellectual property rights of Microsoft Corporation and third parties. Use or distribution of such technology outside of this product is prohibited without a license from Microsoft or an authorized Microsoft subsidiary and third parties.

CAUTION - VISIBLE AND INVISIBLE LASER RADIATION WHEN OPEN. DO NOT STARE INTO BEAM.
 CAUTION - CLASS 1M VISIBLE AND INVISIBLE LASER RADIATION WHEN OPEN, DO NOT VIEW DIRECTLY WITH OPTICAL INSTRUMENTS.
 PRUDENCE - RADIATION LASER VISIBLE ET INVISIBLE QUAND L'APPAREIL EST OUVERT, NE PAS REGARDER LE FAISCEAU.
 PRUDENCE - RADIATION LASER VISIBLE ET INVISIBLE DE CLASSE 1M QUAND L'APPAREIL EST OUVERT, NE JAMAIS REGARDER DIRECTEMENT AVEC DES INSTRUMENTS OPTIQUES.
 VORSICHT - SICHTBARE UND UNSICHTBARE LASERSTRAHLEN BEI GEÖFFNETEM GERÄT. SCHAUEN SIE NIEMALS AUF DEN LASERSTRAHL.
 VORSICHT - SICHTBARE UND UNSICHTBARE LASERSTRAHLEN DER KLASSE 1M BEI GEÖFFNETEM GERÄT. NIEMALS DIREKT MIT OPTISCHEN INSTRUMENTEN HIERAUF SCHAUEN.
 注意 - 開いたり部品をはずしたりするとレーザー光が出ます。ビームを直接見たり触れたりしないこと。

(Inside of product)
(Produktets innside)

Table of contents

Safety precautions	5	Playing back CDs	11
Accessories	6	Others	14
Unit care	6	Notes on CDs	17
Control reference guide	7	Troubleshooting	17
Getting started	9	Specifications	19

About descriptions in these operating instructions

- Pages to be referred to are indicated as “⇒ ○○”.
- The illustrations shown may differ from your unit.

Accessories

For the United Kingdom and Ireland

- 1 AC mains lead**
(K2CT2YY00103)

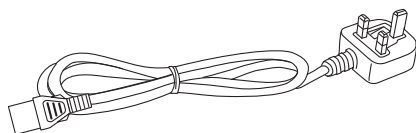

For Continental Europe

- 1 AC mains lead**
(K2CQ2YY00127)

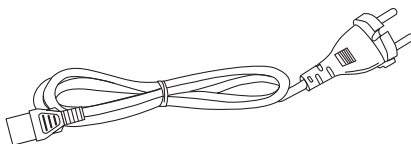

- 1 System connection cable**
(K2KYYYY00233)

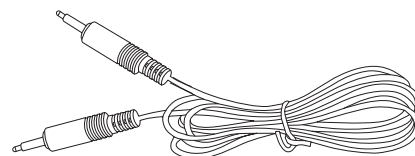

- 1 Coaxial digital cable**
(K2KYYYY00251)

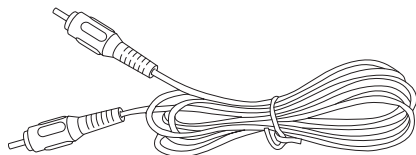

- Product numbers provided in these operating instructions are correct as of December 2014. These may be subject to change.
- Do not use AC mains lead with other equipment.
- In Saudi Arabia, please use the moulded three pin mains plug.

Unit care

Pull out the AC mains lead from the outlet before maintenance. Clean this unit with a soft cloth.

- When dirt is heavy, wring a wet cloth tightly to wipe the dirt, and then wipe it with a soft cloth.
- Do not use solvents including benzene, thinner, alcohol, kitchen detergent, a chemical wiper, etc. This might cause the exterior case to be deformed or the coating to come off.

Control reference guide

This unit

■ Front

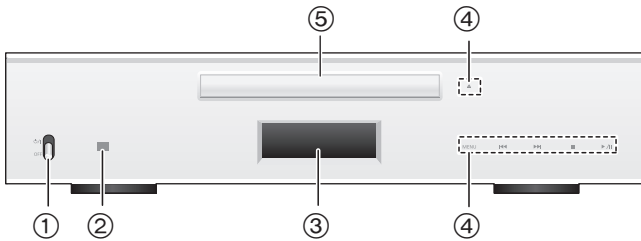

- ① **Power switch lever**
Turn on/off this unit.
 - The remote control do not operate when the power switch lever is in the lowered position.
- ② **Remote control signal sensor**
Distance: Within approx. 7 m directly in front
Angle: Approx. 30° left and right
 - A remote control is not supplied with this unit.
Use the remote control supplied with the SU-C700/ST-C700 to control this unit.
- ③ **Display**
- ④ **Basic control switches**
These switches work just by touching the marks. Each time you touch the switch, there will be a beep sound. (⇒ 14)
- ⑤ **Disc tray**

■ Rear

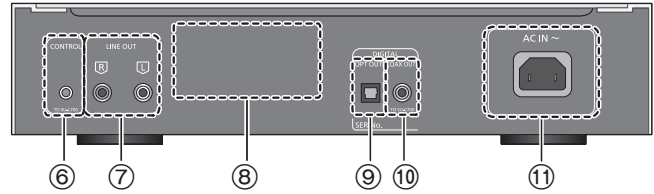

- ⑥ **System terminal [CONTROL] (⇒ 9)**
- ⑦ **Analogue audio output terminal [LINE OUT] (⇒ 10)**
- ⑧ **Product identification marking**
The model number is indicated.
- ⑨ **Digital audio output terminal [OPT OUT] (⇒ 10)**
- ⑩ **Digital audio output terminal [COAX OUT] (⇒ 9)**
- ⑪ **AC IN terminal [AC IN ~] (⇒ 10)**

Remote control (supplied with the SU-C700/ST-C700)

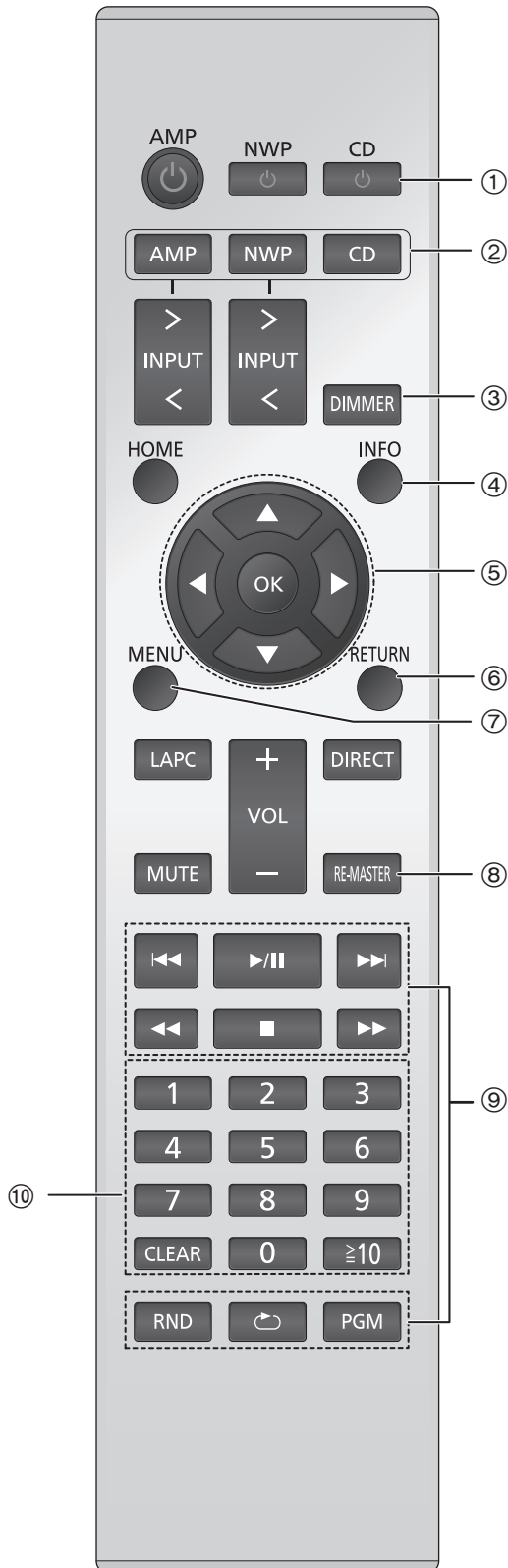

Use the remote control supplied with the SU-C700/ST-C700 to control this unit.

For information on the operations of the SU-C700/ST-C700, please also refer to their operating instructions.

- ① **[CD ⏻]: Standby/on switch**
Press to switch the unit from on to standby mode or vice versa. In standby mode, the unit is still consuming a small amount of power.
 - The remote control do not operate when the power switch lever is in the lowered position.
- ② **[AMP]/[NWP]/[CD]: Select the device to be operated**
- ③ **[DIMMER]: Adjust the brightness of the display, etc. (⇒ 14)**
- ④ **[INFO]: View content information**
- ⑤ **[▲, ▼, ◀, ▶]/[OK]: Selection/OK**
- ⑥ **[RETURN]: Return to the previous display**
- ⑦ **[MENU]: Enter menu (⇒ 13, 14, 15, 17)**
- ⑧ **[RE-MASTER]: Turn on/off Re-master (⇒ 15)**
- ⑨ **Basic playback control buttons**
- ⑩ **Numeric buttons, etc.**
 - To select a 2-digit number
Example:
16: [≥10] → [1] → [6]
 - To select a 3-digit number
Example:
124: [≥10] → [≥10] → [1] → [2] → [4]
 - [CLEAR]: Clear the entered value.

Getting started

- Turn off all equipment before connection and read the appropriate operating instructions.
- Do not connect the AC mains lead until all other connections are complete.
- Insert the plugs of the cables to be connected all the way in.
- Do not bend cables at sharp angles.

System control connection to an SU-C700

- You can output digital audio signals from this unit and play back music.
- You can automatically link this unit with the SU-C700 and operate them easily with the remote control. (⇒ 16)

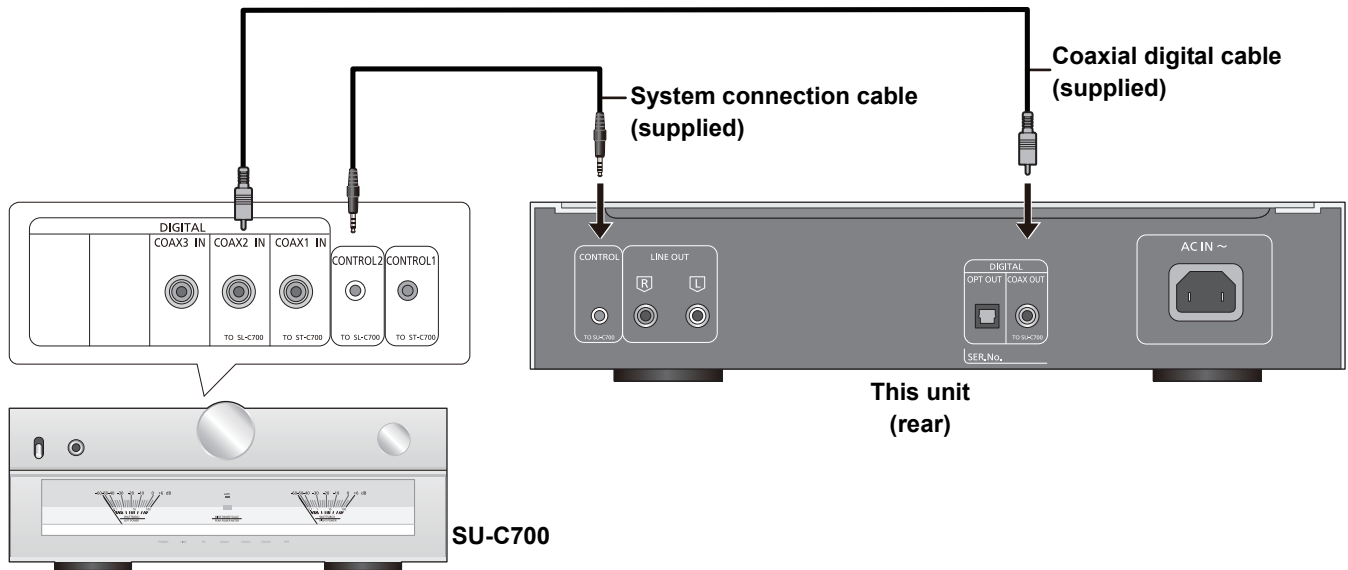

- Do not use any other system connection cables or coaxial digital cables except the supplied one.
- Connect the system connection cable to the system terminal [CONTROL2] of the SU-C700.
- Connect the coaxial digital cable to the digital audio input terminal [COAX2 IN] of the SU-C700.

Connecting to an amplifier and a D/A converter

You can output analogue or digital audio signals from this unit and play back music.

e.g.,

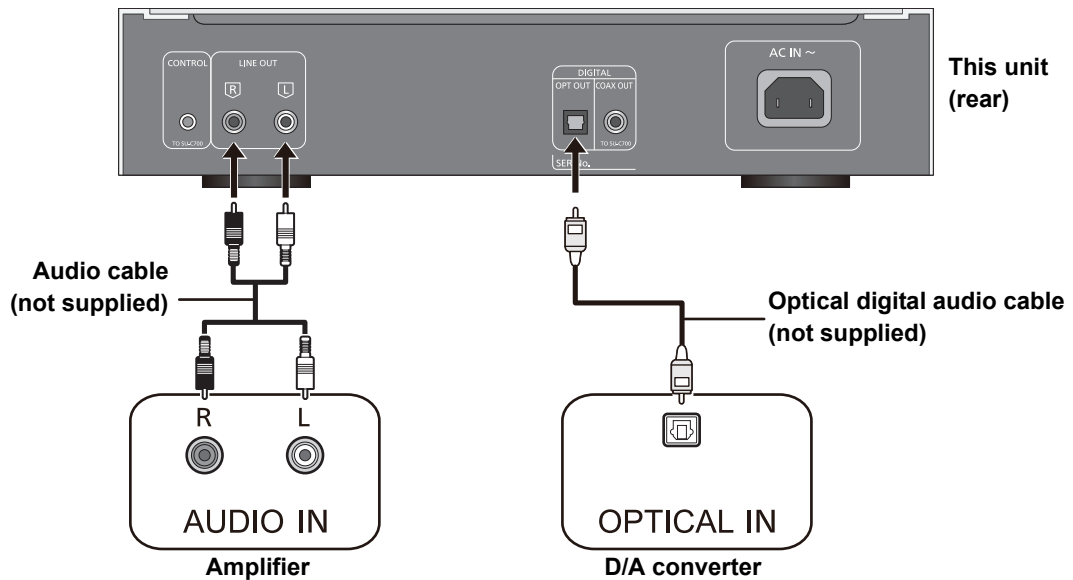

AC mains lead connection

Connect only after all other connections are completed.

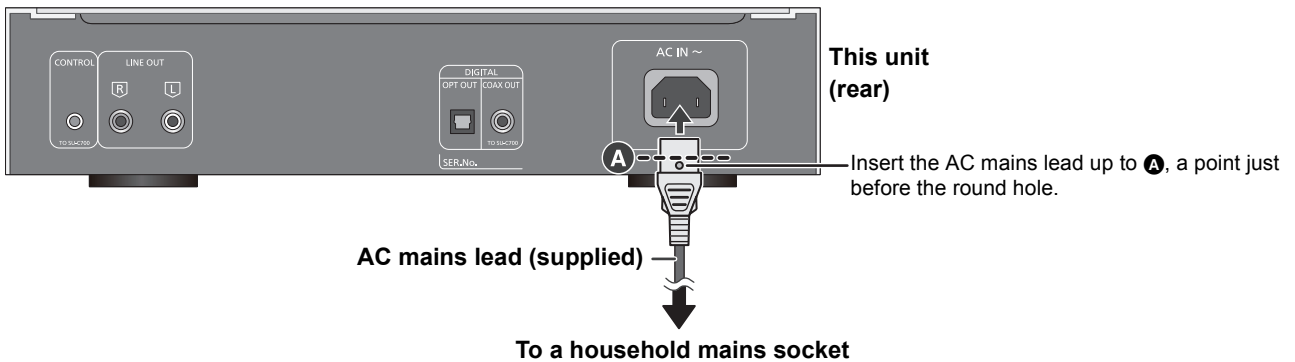

- This unit consumes a small amount of AC power (⇒ 19) even the power switch lever is in the [OFF] position. Remove the plug from the main electrical outlet if you will not be using the unit for an extended period of time. Place the unit so the plug can be easily removed.

Playing back CDs

Refer to “Notes on CDs” (⇒ 17) for information about the discs this unit can play back.

Preparation

- Turn on the connected device (amplifier, etc.) and lower its volume.

1 Raise the power switch lever of this unit to the [I/O] position.

2 Touch [▲] on the unit to open the disc tray and insert a CD.

Place label up in the proper position in the middle of the disc tray.

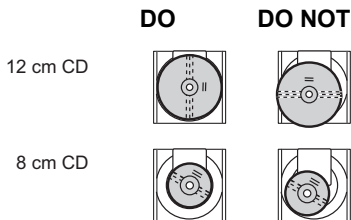

Touch [▲] again to close the disc tray.

3 Touch [▶/||].

Adjust the volume of the connected device. (amplifier, etc.)

Operations during playback

Stop	Touch [■]. <ul style="list-style-type: none"> • When using the SU-C700/ST-C700 remote control, press [CD] first, and then press [■].
Pause	Touch [▶/]. <ul style="list-style-type: none"> • Touch again to restart play. • When using the SU-C700/ST-C700 remote control, press [CD] first, and then press [▶/].
Skip	Touch [◀◀] or [▶▶] to skip track. <ul style="list-style-type: none"> • When using the SU-C700/ST-C700 remote control, press [CD] first, and then press [◀◀] or [▶▶].
Search	During play or pause, touch and hold [◀◀] or [▶▶]. <ul style="list-style-type: none"> • When using the SU-C700/ST-C700 remote control, press [CD] first, and then press and hold either [◀◀] or [▶▶].

■ Random repeat playback

- ① Touch [MENU] repeatedly to select “Random”.
- ② Touch [◀◀, ▶▶] to select an item and then touch [▶/||].

On	All tracks are repeated randomly. <ul style="list-style-type: none"> • “RND ↻” is displayed.
Off	Turns off random repeat mode.



- When using the SU-C700/ST-C700 remote control, press [CD] first, and then press [RND]. (Press again to turn off random repeat mode.)
- Random repeat mode also turns off:
 - When the disc tray is opened.
 - When the unit is turned to standby or off mode.
 - When the auto off function (⇒ 14) works.

■ Repeat playback

- ① Touch [MENU] repeatedly to select “Repeat”.
- ② Touch [◀◀, ▶▶] to select an item and then touch [▶/||].

1 Track	Only plays the selected track. <ul style="list-style-type: none"> • “1 ↻” is displayed.
All Tracks	All tracks are repeated. <ul style="list-style-type: none"> • “↻” is displayed.
Off	Turns off repeat mode.



- When using the SU-C700/ST-C700 remote control, press [CD] first, and then press [↻]. (Press again to turn off repeat mode.)
- Random repeat mode also turns off:
 - When the disc tray is opened.
 - When the unit is turned to standby or off mode.
 - When the auto off function (⇒ 14) works.

Viewing information such as the remaining playback time

- Only available from the SU-C700/ST-C700 remote control:

1 Press [CD].

2 Press [INFO] while playing back or paused.

The information displayed changes each time you press the button.

For CD-DA:

The display changes as follows; elapsed play time of the track, remaining time for the track, and remaining time on the entire disc (or entire programme).

For MP3/WMA:

The display changes as follows; file name, folder name, title name, artist name, album name, format, etc.

Programme playback

This function allows you to programme up to 25 tracks.

- Only available from the SU-C700/ST-C700 remote control:

1 Press [PGM] in the stop mode.

- "PGM" screen will be displayed.

2 Select tracks.

For CD-DA:

Press the numeric buttons

For MP3/WMA:

Select folders/files (⇒ 13)

- Repeat this step to make further selections.

3 Press [▶/||] to start playback.

Operations on the remote control

Stop	Press [■]. <ul style="list-style-type: none">• Programmed content is maintained.
Check the programmed order	Press [◀◀] or [▶▶] in the stop mode.
Add tracks	Do steps 2 through 3 in the stop mode.
Clear the last track	Press [CLEAR] in the stop mode. <ul style="list-style-type: none">• It is not possible to select and clear the desired programmed track.
Cancel programme mode	Press [PGM] in the stop mode. "PGM" disappears. (Programmed content is maintained)



- The programme memory will be cleared:
 - When the disc tray is opened.
 - When the unit is turned to standby or off mode.
 - When the auto off function (⇒ 14) works.
- Program play settings are not possible while playing back a CD.
- Random repeat playback is not possible during programme playback.
- You can also cancel programme mode by operating the touch panel on this unit.
 - ① Touch [MENU] repeatedly to select "Play Mode".
 - ② Touch [◀◀, ▶▶] to select the item and then touch [▶/||].

Selecting folders and files for MP3/WMA CDs

For MP3/WMA CDs, files (MP3/WMA files) may be organized in a hierarchy, with folders containing files and subfolders, as shown below.

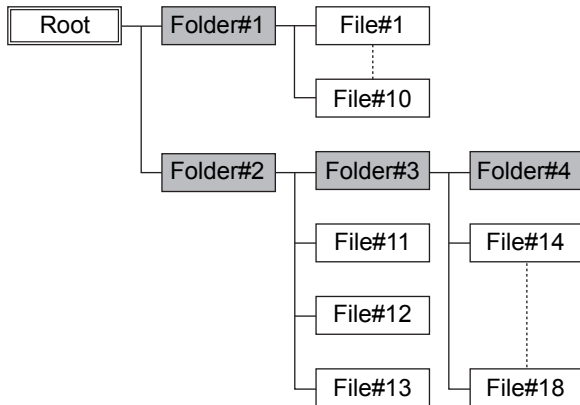

If you don't select a specific MP3/WMA file or folder for playback, all of the MP3/WMA files on the CD will be played in numerical order starting with file #1.

■ Selecting files in folder mode

In folder mode, all folders containing files are shown as the same level, so you can select files without worrying about the structure of the folders. Select while the disc is stopped.

- Operation with the touch panel on the unit:
 - ① Touch [MENU] repeatedly to select "Folder" and then touch [▶/||].
 - The first folder is displayed. ("Root" is displayed if it is the root folder.)
 - ② Touch [◀◀, ▶▶].
 - Another folder name is displayed.
 - ③ Touch [▶/||] so that you can select the files in that folder.
 - Touch [◀◀, ▶▶] to display the files in the folder.
 - Touch [■] to enable selection of a different folder and select different files.
 - ④ Touch [▶/||].
 - Playback starts for the displayed folder or file.
 - Touch [■] to stop playback.

- Operation with the SU-C700/ST-C700 remote control:
 - ① Press [CD].
 - ② Press [MENU].
 - ③ Press [▲, ▼] repeatedly to select "Folder" and then press [OK].
 - The first folder is displayed. ("Root" is displayed if it is the root folder.)
 - ④ Press [▲, ▼] or [◀◀, ▶▶].
 - Another folder name is displayed.
 - ⑤ Press [▶] or [OK] so that you can select the files in that folder.
 - ⑥ The first file name in the folder is displayed.
 - Press [▲, ▼] or [◀◀, ▶▶] to display the files in the folder.
 - Press [◀] or [RETURN] to enable selection of a different folder and select different files.
 - ⑦ Press [▶/||] or [OK].
 - Playback starts for the displayed folder or file.
 - To cancel the procedure at any point, press the [■].

■ Selecting the playback mode

All: Plays back all tracks on the CD.

1 Folder: Plays back the tracks in a folder.

- Operation with the touch panel on the unit:
 - ① Touch [MENU] repeatedly to select "Play Mode".
 - ② Touch [◀◀, ▶▶] to select the item and then touch [▶/||].
- Operation with the SU-C700/ST-C700 remote control:
 - ① Press [CD].
 - ② Press [MENU].
 - ③ Press [▲, ▼] repeatedly to select "Play Mode".
 - ④ Press [◀, ▶] to select the item and then press [OK].

Others

Display brightness

The brightness of this unit's display and the basic control switches can be changed.

- Operation with the touch panel on the unit:

- 1 Touch [MENU] repeatedly to select "Dimmer".
- 2 Touch [◀◀, ▶▶] to select an item and then touch [▶/||].



- When using the SU-C700/ST-C700 remote control, press [DIMMER] to select the brightness.
- When the display is turned off, it will light up only when you operate this unit. Before the display turns off again, "Display Off" will be displayed for a few seconds.

Operation sound setting

You can turn the beep sound on/off.

- The factory default is "On".

- Operation with the touch panel on the unit:

- 1 Touch [MENU] repeatedly to select "Setup" and then touch [▶/||].
- 2 Touch [MENU] repeatedly to select "Beep".
- 3 Touch [◀◀, ▶▶] to select an item and then touch [▶/||].
- 4 Touch [■] twice after you have finished setting.

- Operation with the SU-C700/ST-C700 remote control:

- 1 Press [CD].
- 2 Press [MENU].
- 3 Press [▲, ▼] repeatedly to select "Setup" and then press [OK].
- 4 Press [▲, ▼] repeatedly to select "Beep".
- 5 Press [◀, ▶] to select "On"/"Off" and then press [OK].
- 6 Press [MENU] after you have finished setting.

Auto off function

This unit is designed to conserve its power consumption and save energy. The unit will turn to standby mode automatically if there is no sound and it is not being used for approximately 20 minutes.

- The factory default is "On".

To cancel this function

- Operation with the touch panel on the unit:

- 1 Touch [MENU] repeatedly to select "Setup" and then touch [▶/||].
- 2 Touch [MENU] repeatedly to select "AUTO OFF".
- 3 Touch [◀◀, ▶▶] to select an item and then touch [▶/||].
- 4 Touch [■] twice after you have finished setting.

- Operation with the SU-C700/ST-C700 remote control:

- 1 Press [CD].
- 2 Press [MENU].
- 3 Press [▲, ▼] repeatedly to select "Setup" and then press [OK].
- 4 Press [▲, ▼] repeatedly to select "AUTO OFF".
- 5 Press [◀, ▶] to select "Off" and then press [OK].
 - To enable the output again, select "On".
- 6 Press [MENU] after you have finished setting.



- The auto off function works unless you turn it off, even if you turn off and on this unit.

CD EXTRA

Make settings to play back CD EXTRA discs.

Audio : Plays back CD-DA data.

MP3/WMA : Plays back MP3/WMA data.

- The factory default is "Audio".

• Operation with the touch panel on the unit:

- 1 Touch [MENU] repeatedly to select "Setup" and then touch [▶/||].
- 2 Touch [MENU] repeatedly to select "CD EXTRA".
- 3 Touch [◀◀, ▶▶] to select an item and then touch [▶/||].

• Operation with the SU-C700/ST-C700 remote control:

- 1 Press [CD].
- 2 Press [MENU].
- 3 Press [▲, ▼] repeatedly to select "Setup" and then press [OK].
- 4 Press [▲, ▼] repeatedly to select "CD EXTRA".
- 5 Press [◀, ▶] to select an item and then press [OK].

Listening to more natural-sounding audio (Re-master)

Re-mastering expands the playback band and achieves a higher bit depth to reproduce natural and expansive sound close to original music.

- The factory default is "Off".

• Operation with the touch panel on the unit:

- 1 Touch [MENU] repeatedly to select "RE-MASTER".
 - 2 Touch [◀◀, ▶▶] to select an item and then touch [▶/||].
- Operation with the SU-C700/ST-C700 remote control:
- 1 Press [CD].
 - 2 Press [RE-MASTER] to select "On"/"Off".



- This function works for both the analogue and digital audio outputs.

Setting the upper limit for the sampling frequency during digital output

You can set the upper limit for the sampling frequency for signals output from the digital audio output terminal when [RE-MASTER] is "On". The sampling frequencies you can transmit depend on the device you have connected. Refer to the operating instructions for the device you have connected for details.

- The factory default is "176.4kHz".

• We recommend that you select "176.4kHz" when you have connected this unit and SU-C700 as a system. (⇒ 9)

• Operation with the touch panel on the unit:

- 1 Touch [MENU] repeatedly to select "Setup" and then touch [▶/||].
 - 2 Touch [MENU] repeatedly to select "Digital Output".
 - 3 Touch [◀◀, ▶▶] to select an item and then touch [▶/||].
 - 4 Touch [■] twice after you have finished setting.
- Operation with the SU-C700/ST-C700 remote control:
- 1 Press [CD].
 - 2 Press [MENU].
 - 3 Press [▲, ▼] repeatedly to select "Setup" and then press [OK].
 - 4 Press [▲, ▼] repeatedly to select "Digital Output".

- 5 Press [◀, ▶] to select an item and then press [OK].

- You can select a sampling frequency of 44.1 kHz or 176.4 kHz.

- 6 Press [MENU] after you have finished setting.



- Depending on the music source that you play back, the applied setting may be less effective.
- Depending on the music source that you play back, it may not be possible to achieve the desired audio quality and sound field effect. In such cases, turn off this function.
- It may take some time to output audio when you have adjusted the audio quality.
- This has no effect on analogue audio output.
- Sound may not be output when you set to 176.4 kHz, depending on the device you have connected. Set to 44.1 kHz if this occurs. ([RE-MASTER] will be disabled.)

Remote control code

When other equipment responds to the supplied remote control, change the remote control code.

- The factory default is "Remote Mode 1".

- Only available from the SU-C700/ST-C700 remote control:

Point the remote control at this unit, and press and hold [OK] and the numeric button for at least 4 seconds.

- When the remote control code is changed, the new code will appear on the display for a few seconds.

[OK] + [1]	Set the code to "Remote Mode 1"
[OK] + [2]	Set the code to "Remote Mode 2"



- When the SU-C700/ST-C700 is connected via the system control function, change its remote control code as well as the remote control code for this unit.

Using the system control function

You can automatically link this unit with SU-C700 to operate them.

Preparation

- ① Connect this unit and the SU-C700 with a system connection cable and a coaxial digital cable. (⇒ 9)
- ② Set the power switch lever of this unit and the SU-C700 to the [⏻/|] position.

■ Switching this unit and the SU-C700 to on/standby simultaneously

- When this unit and SU-C700 are in standby mode, while pointing the SU-C700/ST-C700 remote control at this unit, press [CD ⏻] so that this unit and SU-C700 switch on automatically.

■ Switching the SU-C700's input source automatically

When you perform an operation such as playback on this unit, the input source of the SU-C700 will be automatically switched to "COAX2".



- For information on the operations of the SU-C700, please also refer to its operating instructions.

Notes on CDs

■ Compatible CD

- A disc with the CD Logo.



- This unit can play back discs that conform to the CD-DA format.
- The unit may not be able to play some discs due to the condition of the recording.
- Before playback, finalise the disc on the device it was recorded on.

■ Compatible MP3 files

- Supported format: Files with the extension “.mp3” or “.MP3”.
- Compatible compression rate: Between 16 kbps and 320 kbps (stereo).
- Sampling Rate: 32, 44.1, 48 kHz.
- Depending on how you create the MP3 files, they may not play in the order you numbered them or may not play at all.

■ Compatible WMA files

- Supported format: Files with the extension “.wma” or “.WMA”.
- Compatible compression rate: Between 32 kbps and 192 kbps (stereo).
- Depending on how you create the WMA files, they may not play in the order you numbered them or may not play at all.

■ CD-R/RW

- Maximum number of tracks and albums: 499 tracks and 99 albums (Including Root folder).
- Disc formats: ISO9660 level 1 and level 2 (except for extended formats).
- This unit cannot play files recorded using packet write.



- This unit can display the “Windows-1252” character code.

Troubleshooting

Before requesting service, make the following checks. If you are uncertain about some of the check points, or if the solutions indicated in the following guide does not resolve the issue, then consult your dealer for instructions.

Heat buildup of this unit.

- This unit becomes warm when used for a long time. This is not a malfunction.

To return all settings to the factory defaults

When the following situations occur, reset the memory:

- There is no response when buttons are pressed.
- You want to clear and reset the memory contents.
- Operation with the touch panel on the unit:
 - ① Touch [MENU] repeatedly to select “Setup” and then touch [▶/||].
 - ② Touch [MENU] repeatedly to select “Initialization”.
 - ③ Touch [◀, ▶] to select “Yes” and then touch [▶/||].
 - ④ Touch [◀, ▶] to select “Yes” and then touch [▶/||] again.
- Operation with the SU-C700/ST-C700 remote control:
 - ① Press [CD].
 - ② Press [MENU].
 - ③ Press [▲, ▼] repeatedly to select “Setup” and then press [OK].
 - ④ Press [▲, ▼] repeatedly to select “Initialization” and then press [OK].
 - ⑤ Press [◀, ▶] to select “Yes” and then press [OK].
 - ⑥ Press [◀, ▶] to select “Yes” and then press [OK] again.

General

A “humming” sound can be heard during playback.

- An AC mains lead or fluorescent light is near the cables. Keep other appliances and cords away from the cables of this unit.

No sound.

- Check the volume of the connected device (amplifier, etc.).
- Check to see if the cable connections to the input and output terminals are incorrect. If this is the case, turn off this unit and reconnect the cables correctly.
- Insert the plugs of the cables to be connected all the way in.

The sound is interrupted.

- Depending on your environment, the audio may be interrupted during playback. Check the operating instructions of the connected device and the connection to the device.

Playback does not start.

- Depending on your environment or connected devices, it may take some time.

The system control function is not working.

- Connect the system connection cable to the system terminal [CONTROL2] of the SU-C700.
- Connect the coaxial digital cable to the digital audio input terminal [COAX2 IN] of the SU-C700.

The unit turns off automatically.

- Is the auto off function turned on? (⇒ 14)
- If the SU-C700 is connected to this unit via the system control function, this unit may turn off automatically when you turn off the SU-C700. (⇒ 9, 16)

Disc**Incorrect display or play does not start.**

- Make sure that the disc is compatible with this unit. (⇒ 17)
- There is moisture on the lens. Wait for about an hour and then try again.
- Unfinalised CD-R and CD-RW cannot be played back.

Playback takes time to start .

- It may take some time for the disc to load if there are a lot of tracks or folders on it.

**Remote control
(Supplied with the SU-C700/ST-C700)****The remote control does not work properly.**

- To avoid interference, please do not put any objects in front of signal sensor. (⇒ 7)
- Change the remote control code if other products react to this remote control. (⇒ 16)
- If SU-C700/ST-C700 is selected as the equipment to be operated, press [CD] and then try the operation again. (⇒ 8)
- When this unit and the SU-C700 are connected with an audio cable, switch the input of the SU-C700 to "LINE".

Pressing [DIMMER] changes the display, the light and the indicator brightness of the SU-C700/ST-C700.

- [DIMMER] works for the SU-C700/ST-C700 as well as this unit. Turn off the device that you want to maintain the brightness level of, and press [DIMMER].

Messages**The following messages or service numbers may appear on the unit's display.**

"Full"

- The number of programmed tracks is more than 25.

"Not Conditional"

- The function you have tried to use is not available with the current settings. Check the steps and settings.

"No Disc"

- Insert the disc to be played (⇒ 11).

"No File"

- Insert the disc to be played (⇒ 11).
- Insert a disc that has MP3/WMA files on it (⇒ 17).

"No Play"

- A CD that is not in CD-DA , MP3 or WMA format is inserted. It cannot be played.
- Examine the content. You can only play supported format. (⇒ 17)

"Reading"

- The unit is checking the CD information. After this display has disappeared, start operating.

"Remote □" ("□" stands for a number.)

- The remote control and this unit are using different codes. Change the code on the remote control.
 - When "Remote Mode 1" is displayed, press and hold [OK] and [1] for at least 4 seconds.
 - When "Remote Mode 2" is displayed, press and hold [OK] and [2] for at least 4 seconds.

--:--

- The display time is over 99 minutes and 59 seconds.

Specifications

■ GENERAL

Power supply	AC 220 V to 240 V, 50/60 Hz
Power consumption	10 W
Power consumption in standby mode	Approx. 0.5 W
Power consumption in off mode	Approx. 0.5 W
Dimensions (W×H×D)	340 mm×78 mm×295 mm
Mass	Approx. 5.2 kg
Operating temperature range	0 °C to +40 °C
Operating humidity range	35 % to 80 % RH (no condensation)

■ TERMINALS SECTION

Analogue output	
LINE OUT	Pin jack
Digital output	
Optical digital output	Optical terminal
Coaxial digital output	Pin jack
System port	
System control	∅3.5 mm jack

■ DISC SECTION

Playable Disc (8 cm or 12 cm)	CD, CD-R/RW (CD-DA, MP3*1, WMA*1)
MP3	MPEG-1 Audio Layer 3*2
WMA	Windows Media Audio9*3
Pick up	
Wavelength	790 nm
Laser power	CLASS 1
Channel	2 ch (Stereo)
[NORSK]	
Bølgelengde	790 nm
Laserstyrke	KLASSE 1
	Ingen farlig stråling sendes ut

■ ANALOGUE OUTPUT SECTION

Channel	2 ch
Output level	
LINE OUT	2.0 Vrms
Frequency response	2 Hz to 20 kHz (−0.5 dB)
THD+N	0.0018 % (1 kHz, 0 dB)
S/N	117 dB (IHF-A)
Dynamic range	100 dB (IHF-A)



- Specifications are subject to change without notice.
- Mass and dimensions are approximate.

*1 ISO9660 Level-1, Level-2, Joliet, Romeo
Recommended single-session. Recommended finalized disc.

*2 ID3 tag: ver.2(2.2/2.3) and ver.1(1.0/1.1) supported

*3 Not support WMA9 Pro/WMA9 Lossless/WMA9 Voice. Not support file with DRM.

Headquarter Address: Panasonic Corporation
Kadoma, Osaka, Japan
Importer for Europe: Panasonic Marketing Europe GmbH
Panasonic Testing Centre
Winsbergring 15, 22525 Hamburg, Germany

Panasonic Corporation

Web Site: <http://www.panasonic.com>

Ⓔ