

## ***V10 User Manual***





Congratulations on your new Hegel V10. All Hegel products are based on a simple philosophy: Add as little as possible.

We always aim to keep the music signal as close to the original recording as possible. Therefore, we are constantly looking for ways to lower distortion and noise.

By lowering the noise floor, we unveil all the subtle layers in the music, while lowering the distortion enables a better and more precise reproduction of the recording.

At Hegel we work hard to give you quality products that ensures the best possible music experience. Our products are easy to operate, and our minimalistic Scandinavian design is styled to fit with any interior.

“Listening to vinyl is a tactile experience. You carefully open the album jacket, remove the record from the inner sleeve, inspect for dust or scratches, place it on the platter and slowly let the needle drop to let the sound out. It is all about you and your music. Carefully selected for exactly this moment.

With the Hegel V10 we want to make this special experience even better. Developed from the ground up and utilizing some truly clever and unique technologies, the Hegel V10 will give you an unprecedented transparency and soundscape. Making the music you hear as tangible and real as the record it is pressed into.”

Bent Holter   
Founder Hegel Music System

## Index

What's in the box	5
Quickstart	6
General Use	8
Connections	9
Setup	10
Special Functions	13
General Information	14
Additional Information	15





## What's In The Box

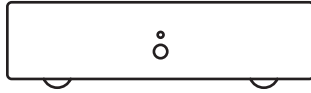

Phono Preamplifier

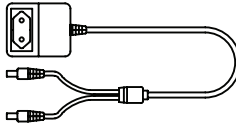

Power Adapter

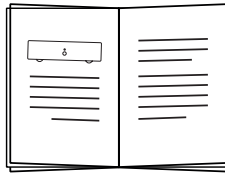

User Manual



Protective Cover

# Quickstart

## 1. Connect your amplifier

Connect with RCA or XLR cables from the V10 to a line input on your amplifier

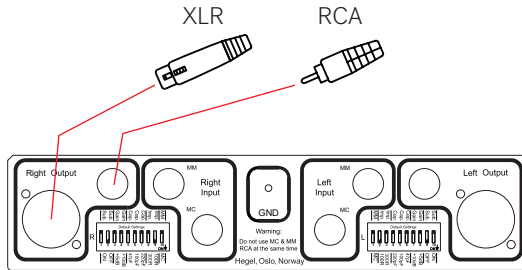

## 2. Connect your turntable

Connect RCA cables from the turntable to the V10  
Use either the MM or the MC input depending on your cartridge\*

Connect the grounding cable to GND if your turntable is equipped with this

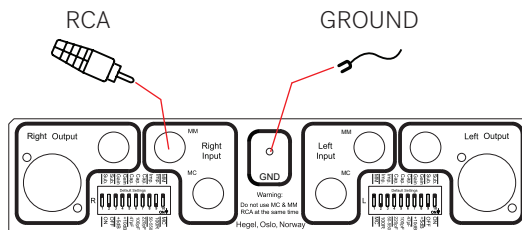

\*The V10 comes configured with a default MM cartridge setting. For MC cartridges and more advanced settings please see page 10 and 11

**Warning! Never connect MM and MC inputs simultaneously**

# Quickstart

## 3. Connect the Power Adapter

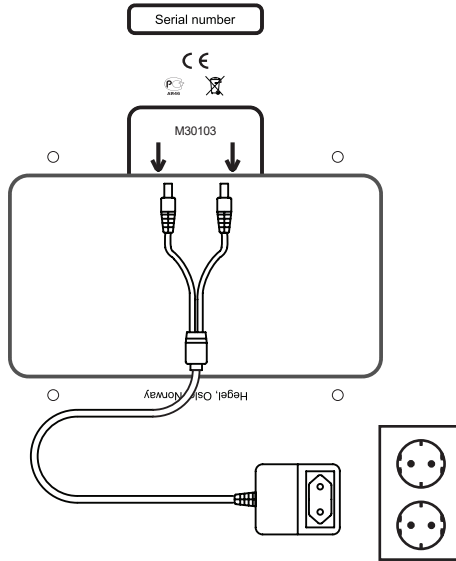

## 4. Turn on the Phono Preamplifier

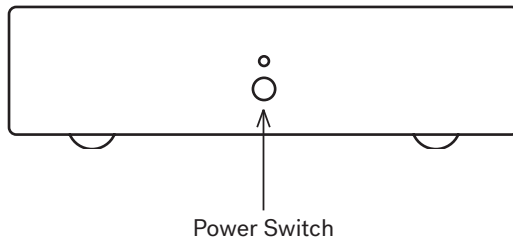

## General Use

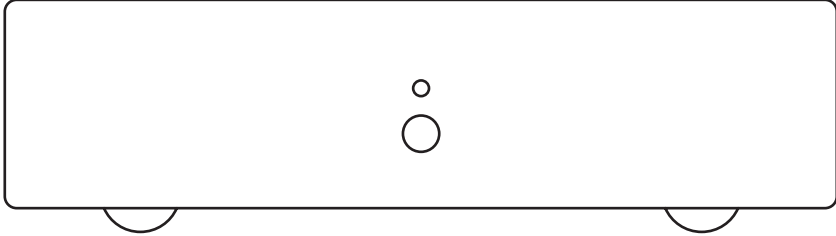

### Power Button

The phono pre-amplifier is switched on and off by pushing the button on the front panel.

**NOTE: When powering up, the outputs are muted and the light flashes. This is to ensure that the ultra-low noise power supplies are stable before use.**

### Auto off

In compliance with the EU Energy Efficiency Directive the V10 will automatically switch off after 15 minutes without sensing a signal.

The auto off has 3 modes:

1: Normal sensitivity

This is the default and recommended setting

2: High sensitivity

Use this mode if the V10 switches off even though you are playing music

3: Disabled

The V10 will not automatically switch off

Change auto off mode:

When powered on, press and hold the power button. The light indicator will flash in sequences one, two or three times indicating the corresponding auto off mode (1, 2 or 3). Keep holding the power button until you have reached the required mode, then release the power button. The light will flash one, two or three times confirming the chosen mode.

### DIP switches

On the back of the phono pre-amplifier there are two rows of DIP switches - one for each channel. These are used for matching the V10 to your cartridge. Please consult your cartridge data and page 10-11 in this manual for the correct settings.

**NOTE: When adjusting the DIP switches, make sure the power is turned off.**



# Connections

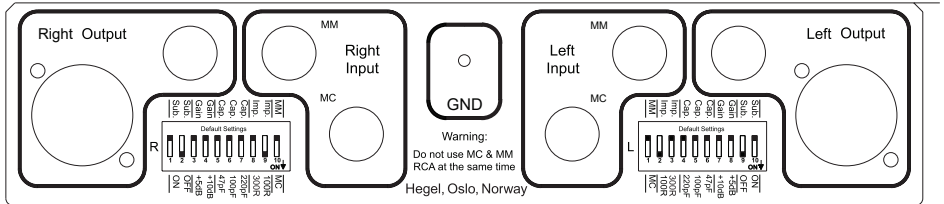

## Analog Inputs

- RCA Right (MM)
- RCA Left (MM)
- RCA Right (MC)
- RCA Left (MC)

The phono pre-amplifier has two sets of analogue signal inputs. One for Moving Magnet (MM) cartridges and one for Moving Coil (MC) cartridges. Please consult your cartridge manual to see which you have.

**Warning! Never use shorting plugs on this product**

**Warning! Never connect MM and MC inputs simultaneously**

## Analog Outputs

- RCA Right
- RCA Left
- XLR Right
- XLR Left

The phono pre-amplifier has two types of analog audio outputs: unbalanced audio signal (RCA/phono) and true balanced audio signal (XLR: pin 2 is positive phase, pin 3 is negative phase, and pin 1 is chassis ground).

## Ground Connection

- GND

We recommend using the balanced XLR outputs from the phono preamplifier as this gives the highest level of sound quality.

## AC Power Connection

- AC Power adapter 2x 18VAC 300mA 230V/120V/100V AC depending on country.
- The AC Power Connection is found underneath the V10.

NOTE: The RCA output signal level is 6dB lower than the XLR output signal level.

## Setup

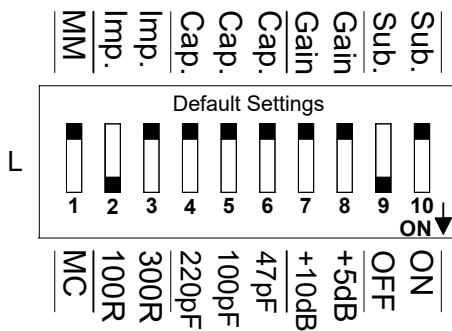
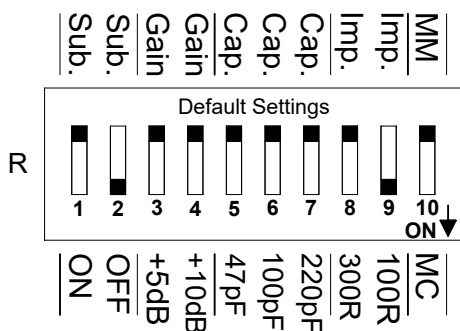

### When to Adjust

The V10 is delivered with a default “plug and play” MM setting. For MC cartridges and more advanced settings it is necessary to adjust the DIP switches on the back side of the V10.

**NOTE:** When adjusting the DIP switches, make sure the power is turned off.

### How to Adjust

The DIP switches are adjusted by switching them on or off according to the settings relevant for your cartridge and turntable setup. Please consult your cartridge manual to see which settings are recommended.

### Default MC setting

When using a MC cartridge, connect the turntable to the MC unbalanced(RCA) input.

To activate the default MC setting it is necessary to switch both Right switch 10 and Left switch 1 from MM to MC.

### Right and Left Side

On the V10 there are two sets of DIP switches. One for the Right side and one for the Left. This layout is chosen to ensure the shortest possible signal paths and thus the best possible audio performance. Make sure both the Left and the Right DIP switch settings are matched.

### Reverse numbering

On the V10 the left and right side DIP switches are numbered in reverse order.

For example:

On the Right side the MM/MC setting is located at DIP switch number 10. On the Left side this setting is located at DIP switch number 1.

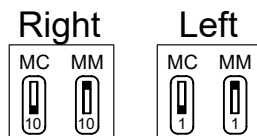

Make sure the settings on both the Right and the Left side are correct before powering up the V10.

# Setup

	Right				Left					
Subsonic Filter	OFF 	ON 	Do not use 	Do not use 	OFF 	ON 	Do not use 	Do not use 		
Gain	MM: 40dB MC: 60dB				MM: 40dB MC: 60dB					
	+0dB 	+5dB 	+10dB 	+12dB 	+0dB 	+5dB 	+10dB 	+12dB 		
Capacitance	MC/+0pF 	+47pF 	+100pF 	+220pF 	+367pF 	MC/+0pF 	+47pF 	+100pF 	+220pF 	+367pF 
Impedance	MM 100R 300R Do not use				MM 100R 300R Do not use					
Cartridge	MC MM				MC MM					

## Cartridge

The V10 supports both MM and MC cartridges. Adjust the switches to match your cartridge.

## Subsonic Filter

A cartridge is a very precise and delicate physical instrument that is susceptible to vibrations. These vibrations can be replicated as an exaggerated movement of the speakers' bass drivers. To alleviate this, you can turn on the Subsonic Filter.

The Subsonic Filter blocks frequencies below 20Hz (-3dB at 20Hz, -18dB at 10Hz, -36dB at 5Hz).

## Gain

The MM input has a gain of 40dB while the MC input has a gain of 60dB. With the V10 gain settings you can increase the output gain if needed. The gain can be increased by 5, 10 or 12dB.

## Capacitance

For MM cartridges adjusting the capacitance according to the cartridge specifications can have an impact on the sound.

The capacitance can be increased by between 47 and 367pF. The total added capacitance will be the sum of all the activated DIP switches. For instance, activating switches 5 (+47pF) and 6 (+100pF) on the Right side will give you an added capacitance of 147pF.

When using MC cartridges, the capacitance should be set to +0pF.

## Impedance

For MC cartridges adjusting the impedance according to the cartridge specifications can have an impact on the sound. The impedance can be set to 100 or 300ohms (R).



## Special Functions

### Advanced Impedance Settings

For most users, the DIP switch impedance settings of either 100 or 300 ohms should be more than sufficient to get the best sound out of a MC cartridge.

However, we at Hegel realize that vinyl enthusiast might want even more fine tuning of the added impedance. That is why we have made it possible to set the impedance of the V10 freely between 50 and 550 ohms.

Please contact your Hegel dealer for more information.

### Advanced MC Gain Settings

For all but the most exotic and low-output MC cartridges the DIP switch gain settings should suffice in getting the output signal exactly right. There is however the occasional cartridge that can benefit from an even higher output.

That is why, in addition to the universal DIP switch gain settings, it is possible to increase the gain of the V10's MC amplifier by an additional 6dB.

Please contact your Hegel dealer for more information.



# General Information

## Technical Specifications

### V10 phono pre-amplifier

Amplifier Typology	Ultra low noise discrete JFET transistor input stage for both MC and MM
Gain XLR Out	MM: 40dB / 45dB / 50dB / 52dB MC: 60dB / 65dB / 70dB / 72dB
Gain RCA Out	MM: 34dB / 39dB / 44dB / 46dB MC: 54dB / 59dB / 64dB / 66dB
MC Load Impedance	100 ohm / 300 ohm / 47kohm
MM Load Capacitance	100pF / 147pF / 200pF / 220pF / 247pF / 320pF / 420pF / 467pF @ 47 kohm
Subsonic Filter:	Switchable on / off, -3dB at 20Hz, -18dB octave
RIAA Accuracy	+/- 0.2dB / 20Hz - 20kHz
Output Noise	-84dB/MM ("A" weighted ref: 0dBV) -81dB/MC ("A" weighted ref: 0dBV)
Output Impedance	XLR / RCA: 200 ohm
Channel Crosstalk	-84dB @1kHz 0dBV
Frequency Response	2Hz-20kHz
Distortion (THD)	MM: < 0.005% MC: < 0.009% @1kHz 0dBV
Inputs	1*unbalanced(RCA) MM 1*unbalanced(RCA) MC
Outputs	1*unbalanced fixed(RCA) 1* balanced fixed(XLR)
Power Consumption	Standby: 0.3W In use: 6.5W
Power Adapter	Hegel Power Adapter M30103
Dimensions with Feet	6cm x 21cm x 28cm 2.4" x 8.3" x 11" H x W x D
Weight	3kg/ 6.6lbs shipping weight

## Disclaimer

Hegel reserves the right to change the specifications without prior notice.

## Transport and Shipment

When packing the V10 phono pre-amplifier for shipping, follow these instructions to avoid damaging the unit:

Place the power adapter in the bottom of the original cardboard box.

Insert the V10 phono pre-amplifier into the plastic bag.

Place the V10 phono pre-amplifier into the shock absorbers.

Place the V10 phono pre-amplifier with absorbers into the original cardboard box.

## Cleaning

Fingerprints or stains on the front panel or top cover can be removed with a cloth moistened with warm water or a mild detergent suitable for cleaning mirrors and windows.

## Additional Information

### Warning

Hegel products should only be opened or serviced by certified technicians. The devices contain electronic components that may cause severe electric shock. Work performed on Hegel products by unqualified personnel may cause serious damage or personal injury.

The products must not be exposed to rain or moisture.

### Warranty

All Hegel products come with a 2-year warranty against defective materials and workmanship.

Opening of the product by non-authorized personnel voids the warranty.

In case you need any assistance with your Hegel product, please find your nearest dealer or distributor by looking at the Hegel web site [www.hegel.com](http://www.hegel.com). If you experience any problems locating your dealer or distributor, please contact [info@hegel.com](mailto:info@hegel.com)

### More Information

For more information, please visit [www.hegel.com/products/phonopreamp/v10](http://www.hegel.com/products/phonopreamp/v10)

### Use and Placement

The Hegel V10 should be placed on a flat, hard surface for proper cooling. The phono pre-amplifier should not be placed next to or on top of electronic components that generate a lot of heat. Nor products that have large power transformers, as this might affect the sound performance of the product. The V10 should never be covered while in use.

The V10 phono preamplifier needs some break-in time before maximum sound quality can be experienced.

Never lift the V10 by its connectors, as it may cause damage to the product.



V9



